







20 005 706

- avec structure WAVES
- diamètre de percement 32 mm
- rosace 60 x 47 mm
- avec marquage chaud



	Champagne brossé (Or 22cts)	20 005 706-46
	Chrome	20 005 706-00
	Platine brossé	20 005 706-06
	Dark Chrome	20 005 706-19
	Champagne (Or 22cts)	20 005 706-47
	Dark Platinum brossé	20 005 706-99

20 005 706

mm [inches]



Diagramme de débit



Certificats

IAPMO_N-4976.

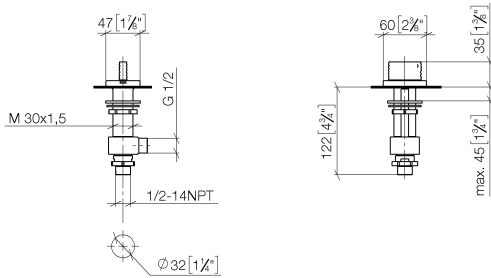
LGA_28687.

IAPMO_6397.

WRAS_240202020.

20 005 706

Les pièces pour les autres finitions peuvent être trouvées ici : Chrome

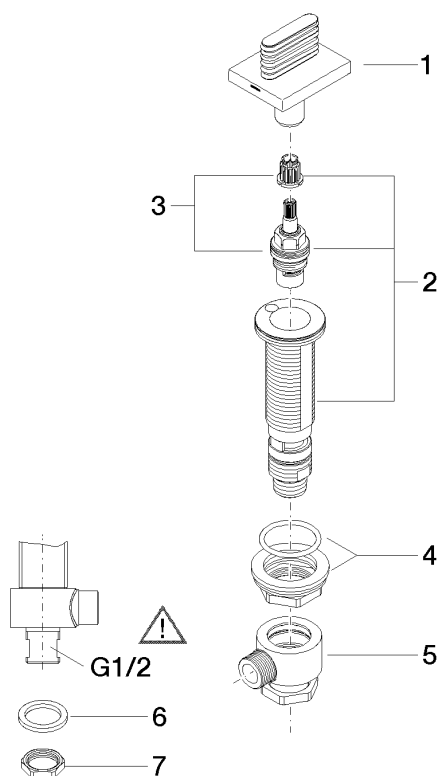

Liste des pièces de rechange

N°	Article Numéro	Désignation	Fréquence de montage	Délai de livraison
1	90 20 70 055 07-46	poignée (hot)	1	30
2	04 17 11 058 52 90	partie latérale	1	2
3	90 90 03 152 00 90	tête céramique	1	2
4	04 23 10 032 78 90	set de fixation	1	2
5	04 17 11 023 10 90	raccord multiple	1	2
6	90 23 30 040 00-46	joint américain	1	-
La pièce de rechange ne peut plus être commandée, veuillez commander l'article de remplacement				
7	09 30 11 059 90	rondelle	1	2
8	09 23 10 012 90	écrou	1	2